

D 531 A

DOUBLE OVEN

User Manual

Please read this manual first.

Dear Customer,

We would like you to obtain best performance with your product that has been manufactured in modern facilities and passed through strict quality control procedures.

Therefore, we advise you to read through this User Manual carefully before using your product and keep it for future reference. If you hand over the product to someone else, deliver the User Manual as well.

The User Manual will help you use the product in a fast and safe way.

- Read the User Manual before installing and starting the product.
- You must strictly observe the safety instructions.
- Keep this User Manual within easy reach for future reference.
- Also read other documents supplied with the product.
Remember that this User Manual may also be applicable for several other models.
Differences between models are explicitly identified in the manual.

Explanation of symbols

Throughout this User Manual the following symbols are used:

 Important information or useful hints about usage.

 Warning for hazardous situations with regard to life and property.

 Warning for electric shock.

 Warning for risk of fire.

 Warning for hot surfaces.

Table of Contents

1	General information	4	5	How to use the hob	15
	Overview	4		General information on cooking.....	15
	Technical Data	5		How to use hobs.....	15
	Accessories supplied with the unit.....	6	6	How to operate the oven	17
2	Safety instructions	7		General information on baking, roasting and grilling	17
	Basic safety instructions.....	7		How to use the electric oven	18
	Safety when working with electricity .	8		Cooking times table.....	18
	Intended use	8		How to operate the grill -Top oven	19
	Safety for children	8	7	Maintenance and care	20
3	Installation	9		General information	20
	Before installation	9		How to clean the hob.....	20
	Installation and connection.....	9		Cleaning the control panel.....	20
	Disposal	11		Cleaning the oven	20
	Disposing of packaging material	11		Removal of oven door.....	20
	Old equipment.....	11	8	Troubleshooting	22
	Future transportation.....	12	9	Guarantee and Service	23
4	Preparation	13			
	Tips for saving energy	13			
	Initial operation	13			
	First cleaning of the appliance	13			
	Initial heating	13			

1 General information

Overview

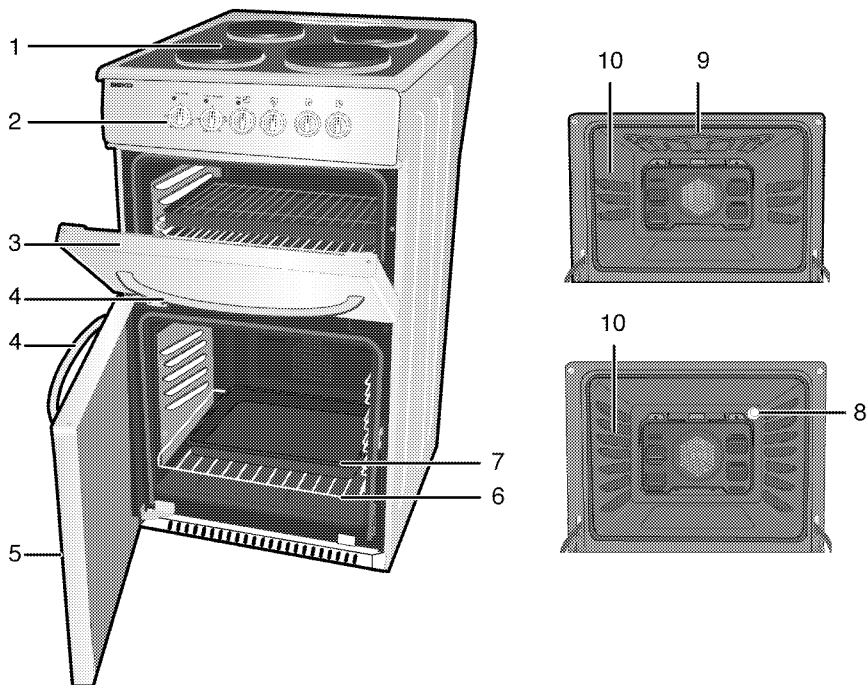

- 1 Burners' plate
- 2 Control panel
- 3 Top oven door
- 4 Handle
- 5 Main oven door

- 6 Wire shelf
- 7 Tray
- 8 Lamp
- 9 Grill heating element
- 10 Shelf positions

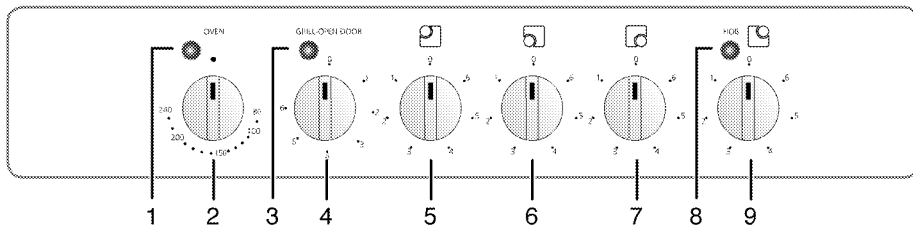

- 1 Thermostat lamp for main oven
- 2 Main oven function knob
- 3 Thermostat lamp for top oven
- 4 Top oven function knob
- 5 Hotplate Rear left

- 6 Hotplate Front left
- 7 Hotplate Front right
- 8 Warning lamp
- 9 Hotplate Rear right

Technical Data

GENERAL	
Outer dimensions (height/width/depth)	900 mm/500mm/600 mm
Voltage/frequency	230 V ~ 50 Hz
Total electric consumption	10.4 kW
Fuse protection	min. 32 A
Cable type / cross section	H05VV-FG 3 x 2,5 mm ² or equivalent
Cable length	max. 2 m
HOB	
Burners	
Rear left	Hotplate
Size	145 mm
Power	1000 W
Front left	Hotplate
Size	180 mm
Power	2000 W
Front right	Hotplate
Size	145 mm
Power	1500 W
Rear right	Hotplate
Size	180 mm
Power	1500 W
OVEN/GRILL	
Top oven	Grill oven
Grill power consumption	2.0kW
Main oven	Conventional oven
Energy efficiency class [#]	A

[#] Basis: In electrical ovens, the data on energy labels are in conformity with EN 50304. Values were determined under standard load and convection/hot air (if available). Heating mode with an energy efficiency rating specified by EN 50304 is determined in accordance with below priority order depending on functions (modes) availability on the product. 1- Eco fan heating, 2-Slow cooking, 3-Fan heating (hot air), 4-Top and bottom heat with convection air, 5-Top and bottom heating.

Accessories supplied with the unit

 Accessories supplied can vary depending on the product model. All the accessories described in the user manual may not exist on your product.

Small baking tray

Can be used for small portions. This baking tray is placed onto the wire shelf.

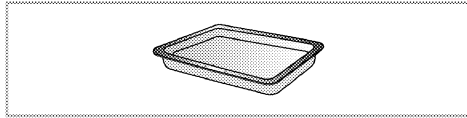

Wire shelf

Can be used for roasting and as a deposit for baking, roasting and casserole dishes.



Small wire shelf and fat pan with handle

Can be used for both grilling and fat collection. The fat pan is placed onto the large wire shelf.

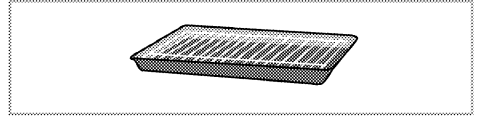

- Apply handle only at the holes in the middle of the fat pan.
- Remove handle for grilling.

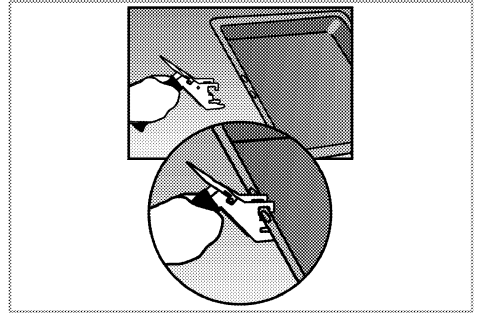

2 Safety instructions

Basic safety instructions

- The manufacturer reserves its right to make changes in the technical specifications in order to improve the appliance quality without any prior notice. Figures included in this manual are for schematic purpose only and may not match exactly with your appliance. Values stated on the markings of the appliance or in other printed documents supplied with the appliance are obtained under laboratory conditions as per relevant standards. These values may vary according to the usage of the appliance and ambient conditions.
- This appliance is not intended for use by persons (including children) with reduced physical, sensory or mental capabilities, or lack of experience and knowledge, unless they have been given supervision or instruction concerning use of appliance by a person responsible for their safety. Children should be supervised to ensure that they do not play with the appliance.
- "An additional protective means to avoid contact with the oven door is available. This part should be fitted when young children are likely to be present."
- Never use when judgement or coordination is impaired by the use of alcohol and/or drugs.
- Do not operate the appliance if it is defective or shows any visible damage.
- Do not carry out any repairs or modifications on the appliance. However, you may remedy some malfunctions; see *Troubleshooting*, page 22.
- Be careful when using alcoholic drinks in your dishes. Alcohol evaporates in high temperatures and may catch fire when it comes in contact with hot surfaces.
- Do not heat closed food containers and glass jars. Pressure that may build-up in the jar can cause it to burst.
- Ensure that no flammable materials are adjacent to the appliance as the sides become hot during use.
- Do not leave empty pots or pans on plates that are switched on. They may get damaged.
- Since it may be hot, do not leave plastic or aluminum dishes on the surface of appliance. These kind of dishes should not be used to keep food either.
- Do not place baking trays, dishes or aluminium foil directly onto the bottom of the oven. The heat accumulation might damage the bottom of the oven. Keep all ventilation slots clear of obstructions.
- Appliance may be hot when it is in use. Never touch the hot burners, inner sections of the oven, heating elements etc. Keep children away!

- Always use heat-resistant gloves when putting or removing the dishes into/from your oven.
- Don't use the cooker with front door glass removed.
- Rear surface of the oven gets hot when it is in use. Gas / Electric connection should not touch the rear surface, otherwise the mains cable may get damaged. Do not trap the mains cable between the hot oven door and frame. Do not route the mains cable over the hot cooking section. Otherwise, cable insulation may melt and cause fire as a result of short circuit.
- Check all controls on the appliance are switched off after use.

 For the warranty to be valid, the appliance must be installed by a qualified person in accordance with current regulations.

Safety when working with electricity

- Any work on electric equipment and systems may only be carried out by authorized qualified persons.
- In case of any damage, switch off the appliance and disconnect it from the mains supply by removing the fuse or switching off the circuit breaker.
- Ensure that the fuse rating is correct.

Intended use

This product is designed for domestic use. Commercial use is not admissible.

This product should not be used for warming the plates under the grill, drying towels, dish cloths and etc. by hanging them on the handles and for heating purposes.

The manufacturer shall not be liable for any damage caused by improper use or handling errors.

The oven can be used for defrosting, baking, roasting and grilling food.

Safety for children

- Accessible parts of the appliance will become hot whilst the appliance is in use and until the appliance has cooled, children should be kept away.
- Accessible parts may be hot when the grill is in use. Young children should be kept away.
- Do not store any items above the appliance that children may reach.
- The packaging materials will be dangerous for children. Keep the packaging materials away from children. Please dispose of all parts of the packaging according to environmental standards.
- When the door is open, do **not** load any heavy object on it and do **not** allow children to sit on it. It may overturn or door hinges may get damaged.

3 Installation

Before installation

To ensure that critical air gaps are maintained under the appliance, we recommend that this appliance is mounted on a solid base and that the feet do not sink into any carpet or soft flooring.

The kitchen floor must be able to carry the weight of the appliance plus the additional weight of cookware and bakeware and food.

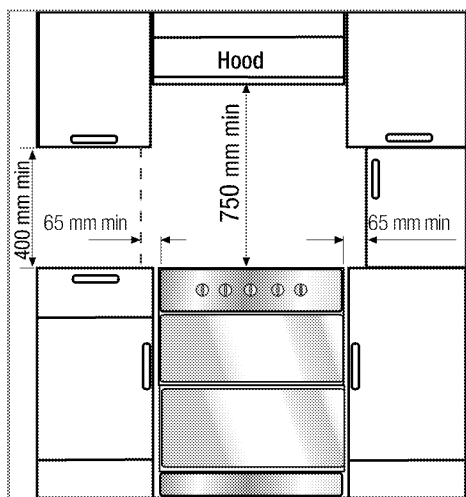

A safety distance must be left between the appliance and the kitchen walls and furniture. See figure (values in mm).



- It can be used with cabinets on either side but in order to have a minimum distance of 400mm above hotplate level allow a side clearance of 65mm between the appliance and any wall, partition or tall cupboard.
- It can also be used in a free standing position. Allow a minimum distance of 750mm from the hob surface to adjacent

surfaces above the hob surface and 600mm to a cabinet above.



- If a appliance hood is to be fitted, refer to the manufacturer's instructions regarding fixing height.
- Movement of your appliance is most easily achieved by lifting the front as follows and pulling towards. Open the top oven door and the bottom oven door sufficiently to allow a comfortable grip on the underside front edge of the oven roofs. While gripping, it should be avoided to damage any grill elements or oven interior furniture.
- The appliance corresponds to device class 1, i.e. it may be placed with the rear and **one** side to kitchen walls, kitchen furniture or equipment of any size. The kitchen furniture or equipment on the **other** side may only be of the same size or smaller.
- Any kitchen furniture next to the appliance must be heat-resistant (100 °C min.).

Installation and connection

-  Do not install the appliance next to refrigerators or freezers. The heat emitted by the appliance will lead to an increased energy consumption of cooling appliances.
- Appliance to be installed in accordance with the local authority requirements for gas, electricity and any other authority having jurisdiction.

- Carry the appliance with at least two persons.
-  **Material damage!**
The door and/or handle must not be used for lifting or moving the appliance.
- The appliance must be placed directly on the floor. It must not be placed onto a base or a pedestal.
-  **Risk of explosion by damage of the safety tube!**
The safety tube must not be clamped, bent or trapped or come into contact with hot parts of the appliance.

Connection to the mains supply

-  **This appliance must be earthed!**
Our company shall not held responsible for any damage caused by using the appliance without earthed socket.
-  **Risk of electric shock, short circuit or fire by unprofessional installation!**
The appliance may be connected to the mains supply only by an authorized qualified person and the appliance is only guaranteed after correct installation.
-  **Risk of electric shock, short circuit or fire by damage of the mains lead!**
The mains lead must not be clamped, bent or trapped or come into contact with hot parts of the appliance.
If the mains lead is damaged, it must be replaced by a qualified electrician.

The mains supply data must correspond to the data specified on the rating plate of the appliance. The rating plate is either seen when the door or the lower cover is opened or it is located at the rear wall of the appliance depending on the appliance type.
The supply cable of the appliance must correspond to the specifications; see technical data table *Technical Data*, page 5.

-  **Risk of electric shock!**
Before starting any work on the electrical installation, please disconnect the appliance from the mains supply.

1. A mains lead is not supplied with the appliance. The mains lead must be connected by an authorised person and be of the type mentioned in the technical table page or of an equivalent type. A wiring diagram is provided on following explanations.

This product must only be installed by a qualified electrician eg local electricity company or NICEIC registered contractor to a suitable double-pole control unit with a minimum contact clearance of 3mm in all poles and with a minimum rating please consider, which should be fitted adjacent to (but not above) the cooker in accordance with IEE regulations. Failure to observe this instruction may result in operational problems and invalidation of the product warranty. Additional protection by a residual current circuit breaker is recommended.

- The cable must have conductors of sufficiently high cross sectional area to prevent overheating and deterioration.

Recommended cross-section area is six square millimetres (6.00mm²). The mains lead must conform to BS6004.

This appliance must be earthed.

The mains lead must pass through the cable clamp.

The mains lead should be routed away from the appliance and in particular ventilation slots, the vent outlet and should not be obstructed when pushed in to position between the appliance and the wall and/or cabinets.

- Open the terminal block cover with screwdriver.
- Pass the mains lead through the cable clamp under the terminal and fix the mains lead to main body with supplied screw via cable tightener.
- Connect the cables according to the supplied diagram.
- Close the cover of the terminal block once the wiring is complete.

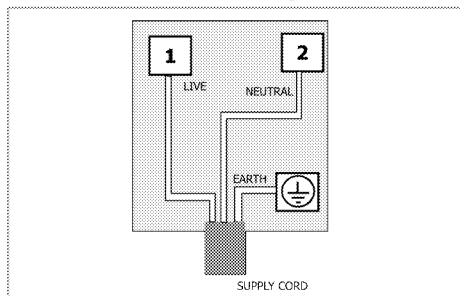

-  Mains lead must not be longer than 2 metres for safety reasons.

- The mains lead should be routed away from the appliance and not be

trapped between the appliance and the wall.

- Position appliance up to the kitchen wall.
- To align the appliance with the worktop, adjust the feet turning right or left hand as required.

Final check

- Switch electricity supply on.
- Check electrical functions.

Disposal

Disposing of packaging material

Packaging materials are dangerous to children. Keep packaging materials in a safe place out of reach of children. Packaging materials of the product are manufactured from recyclable materials. Dispose of them properly and sort in accordance with recycled waste instructions. Do not dispose of them with normal domestic waste.

Old equipment



This appliance bears the selective sorting symbol for waste electrical and electronic equipment (WEEE). This means that this appliance must be handled pursuant to European Directive 2002/96/EC in order to be recycled or dismantled to minimize its impact on the environment. For further information, please contact your local or regional authorities.

Electronic appliances not included in the selective sorting process are potentially dangerous for the environment and human health due to the presence of hazardous substances.

Future transportation

-  Do not place other items on the top of the appliance. The appliance must be transported upright.

Store the appliance's original box and transport the appliance in its original carton. Follow the guidance marks that are printed on the carton.

-  Verify the general appearance of your equipment by identifying possible damage during the transportation.

To prevent the wire shelf and tray inside the oven from damaging the oven door, place a strip of cardboard onto the inside of the oven door that lines up with the position of the trays. Tape the oven door to the side walls.

If you do not have the original carton

Pack the appliance in bubble wrap or thick cardboard and tape it securely in order to prevent damage during transportation.

4 Preparation

Tips for saving energy

The following tips will help you to use your appliance in an ecological way and to save energy:

- Use dark coloured and enamel coated trays, since the heat transmission will be better.
- While cooking your meals, perform a preheating operation if it is advised in the user manual or cooking instructions.
- During cooking, do not open the oven door frequently.
- Try to cook more than one type of meal within the oven at the same time (You can cook two different meals at the same time by locating cooking bowls on the same shelf). It will be suitable to cook more than one meal after each other. The oven will already be hot.
- Defrost frozen meals before cooking them.
- You can save energy by switching off your oven a few minutes before the end of the cooking time (The oven door should not be opened).
- Use pots/pans with lids for cooking. Without a lid, the energy consumption may be up to four times higher.
- Choose the burner/plate which is suitable to the saucepan base. Always choose the correct size of saucepans for your meals. For larger burners/plates more energy is needed.
- Take care to use flat base saucepans while cooking on electrical cookers.

Pots with an even and thick bottom provide better thermal conduction. You can save up to 1/3 of electricity.

- Pots and pans should match the size of plates. The bottom of the pot or pan should not be smaller than the plate.
- Keep plates and pan bottoms clean. Dirt will reduce the heat transmission between plate and pan bottoms.
- In case of longer cooking times, switch off the plate 5 to 10 minutes before the end of the cooking time. When you use the residual heat, you can save up to 20 % of electricity.

Initial operation

First cleaning of the appliance

-  The surface may get damaged by some detergents or cleaning materials. Do not use aggressive detergents, cleaning powder/cream or any sharp objects.

1. Remove all packaging materials.
2. Wipe the surfaces of the appliance with a damp cloth or sponge and dry with a cloth.

Initial heating

-  Hot surfaces may cause burns! Do not touch the hot surfaces of the appliance. Use oven gloves. Keep children away from the appliance.

 Smell and smoke may emit during first heating. Ensure that the room is well ventilated.

Any production residues or conservation layers must be burnt off before the first use. Heat up the appliance for about 30 minutes and then switch it off.

Electric oven

1. Take all baking trays and racks from the oven.
2. Close oven door.

3. Select the highest temperature with the thermostat knob; see *How to use the electric oven, page 18*.
 4. Heat approximately 30 minutes.
 5. Switch off oven; see *How to use the electric oven, page 18*
1. Any production residues or conservation layers must be burnt off before the first use. Adjust the hotplate to mid position and leave on for about 8 minutes. Do not place any pans or other cooking utensil on the hotplate during this process.

5 How to use the hob

General information on cooking

⚠ Risk of fire by overheated oil!
When you heat oil, do not leave it unattended.

Never try to extinguish the fire with water! When oil has caught fire, immediately cover the pot or pan with a lid. Switch off the hob if safe to do so and phone the fire service.

- Ensure handles of pans cannot accidentally be caught or knocked and do not get hot by adjacent heating zones. Avoid pans that are unstable and easily tipped. Pans that are too heavy to move easily when filled can also be a hazard. Only use flat bottomed pots or pans.
- Use pans which have sufficient capacity for the amount of food being cooked so they don't boil over and cause unnecessary cleaning.
Do not place lids on the burners. Always position pans centrally over the burners. When transferring pans from one burner to another always lift the pans do not slide them.

How to use hobs

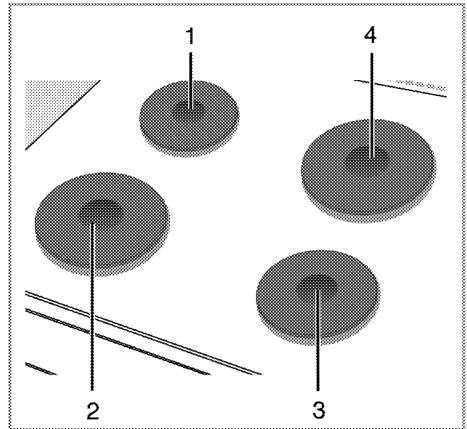

- 1 Hotplate 14-16 cm
- 2 Hotplate 18-20 cm
- 3 Hotplate 14-16 cm
- 4 Hotplate 18-20 cm is list of advised diameter of pots to be used on related burners.

How to use electrical hobs

The knobs for the hob can be rotated in either direction to provide fully variable heat control.

- i** Quick heating hotplates, if any, are marked with a red point.

Overheat protection

Plates of more than 1000 W burner power are equipped with overheating protection. The overheating protection reduces the burner power under the following conditions:

- No pot or pan on the plate.
- An empty pot or pan on the plate.
- Pot or pan bottom very uneven.

The plate is switched off when the position indicator is in the OFF (top) position.

Switching the plate on

The hob control knobs are used for operating the plates. To obtain the desired cooking power, turn the hob control knobs to the corresponding level.

Cooking level	1	2 – 3	4 – 6
	warming	stewing, simmering	cooking, roasting

Switching the plate off

Turn hob control knob to off position (top).

6 How to operate the oven

General information on baking, roasting and grilling

-  Risk of scalding by hot steam!
Take care when opening the oven door as steam may escape.

Tips for baking

- Use non-stick coated appropriate metal plates or aluminum containers or heat-resistant silicone moulds.
- Make best use of the space on the rack.
- It is recommended to place the baking mould in the middle of the rack.
- Select the correct shelf position before turning the oven or grill on - don't move oven shelves when hot.
- Keep the oven door closed.

Tips for roasting

- Seasoning with lemon juice and black pepper will improve the cooking performance when cooking a whole chicken, turkey or a large piece of meat.
- Meat with bones takes about 15 to 30 minutes longer before it is cooked than a roast of the same size without bones.
- You should calculate about 4 to 5 minutes cooking time per centimeter height of the meat.
- Let meat rest in the oven for about 10 minutes after the cooking time. The juice is better distributed all over the roast and does not run out when the meat is cut.

- Fish in a fire-resistant dish should be placed on the rack at the medium or lower level.

Tips for grilling

Grilling is ideal for cooking meat, fish and poultry and will achieve a nice brown surface without it drying out too much. Flat pieces, meat skewers and sausages are particularly suited for grilling as are vegetables with a high water content such as tomatoes and onions.

- Distribute the pieces to be grilled on the wire shelf.
- If the grilling is on the wire shelf, locate a dripping pan under it in order to collect the fat.
- Add some water in the dripping pan for easy cleaning.

Temperature conversion

The following table will help you to convert temperatures from degrees Celsius to degrees Fahrenheit.

Celsius °C	Fahrenheit °F
50	122
70	150
80	175
100	200
110	225
120	250
140	275
150	300
160	325
180	350
190	375
200	400
220	425
230	450
250	480
300	572

How to use the electric oven

As your appliance has two ovens please ensure that the appropriate function and thermostat control are selected for the oven you wish to use.

Select temperature and operating mode

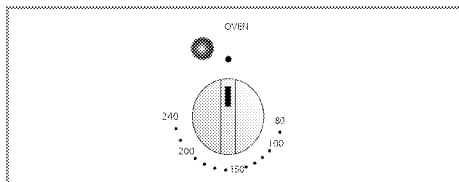

1. Set the function knob to the desired temperature.

» The oven heats up to the adjusted temperature and maintains it. During heating, temperature lamp stays on.

Switch off electric oven

Turn function knob to off position (top).

Cooking times table

 The values indicated in the table below are data indicative. They may vary according to the type of food as well as your preferences of cooking.

Baking and roasting

 Level 1 is the **bottom** level in the oven.

Food	Rack position	Temperature	Cooking time (approx.)
Beef	1	180...200 °C	25 min. per 450 g + 30 min.
Lamb	1	180...200 °C	25 min. per 450 g + 30 min.
Pork	1	180...200 °C	30 min. per 450 g + 25 min.
Poultry	1	180...200 °C	25...30 min. per 450 g + 25 min.
Casseroles	2	140...160 °C	90...120 min. ^s
Fruit cake	1 ... 2	140...160 °C [#]
Small cakes	3	160...180 °C	20...25 min.
Victoria sandwich	2	160...180 °C	20...25 min.

^s depending on quantity/ [#] depending on size

How to operate the grill -Top oven

 Hot surfaces may cause burns! Children must be kept away. **When the door fully open, it remains tilted slightly, so that any spillage will be directed away from you.**

 Do not use the upper level for grilling.

Switch on grill

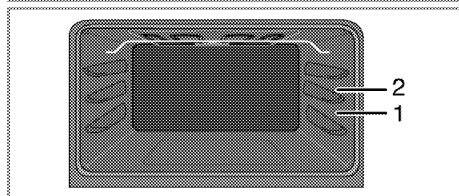
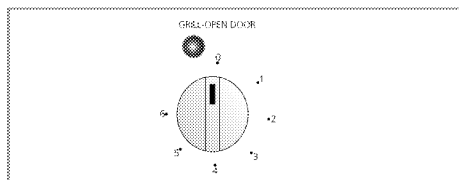

Turning the adjustable grill control knob clockwise, provides grilling in several levels.

1. Open grill door.
2. Set the grill to position 4 and preheat for approximately 5 minutes, if it is necessary.
3. Then set desired grill setting.
» The control lamp is switched on.

Switch off grill

1. Turn grill control knob to off position (top).
 - Put big or medium-sized portions in correct shelf position under the grill heater for grilling.
 - Food which requires browning only should be placed under the hot grill, either in the grill pan, or on the floor of the grill compartment, according to the depth of the dish. The grill pan wire grid can be removed.
 - Plates and dishes placed on the floor of the grill compartment will be heated when main oven is in use.
 - Do not switch on the grill when using the compartment for storage.

7 Maintenance and care

General information

- ⚠ Risk of electric shock!
Switch off the electricity before cleaning appliance to avoid an electric shock.
- ⚠ Hot surfaces may cause burns!
Allow the appliance to cool down before you clean it.
- ⓘ The surface may get damaged by some detergents or cleaning materials.
Do not use aggressive detergents, cleaning powder/cream or any sharp objects.

Clean the appliance thoroughly after each use; in this way it will be possible to remove cooking residues more easily, thus avoiding these from burning the next time the appliance is used.

No special cleaning agents are required for cleaning the appliance. It is recommended to use warm water with washing liquid, a soft cloth or sponge and use a dry cloth for drying.

Do not use any abrasive cleaning materials!

- ⓘ Do not use steam cleaners for cleaning.

How to clean the hob

Electrical hobs

1. Switch plates off and let cool.
2. If necessary, treat plates with a cleaning agent (cleaner/conditioner available in selected stores).

3. Dry by switching on for a few minutes.
4. Apply a thin coat of cooking oil from time to time to provide a protective coating.

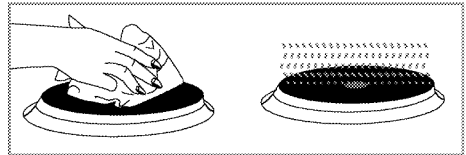

Cleaning the control panel

- ⓘ Damage of the control panel!
Do not remove the control knobs for control panel cleaning.

Clean control panel and control knobs.

Cleaning the oven

No oven cleaner or any other special cleaning agent is required for cleaning the oven. It is recommended to wipe the oven with a damp cloth while it is still warm.

Clean oven door

Don't use any harsh abrasive cleaners or sharp metal scrapers for cleaning the oven door. They could scratch the surface and destroy the glass.

Removal of oven door

The oven door can be disassembled for easier cleaning of the inner space of the oven.

1. Open oven door entirely.
2. Press hinged shackles back at both sides.

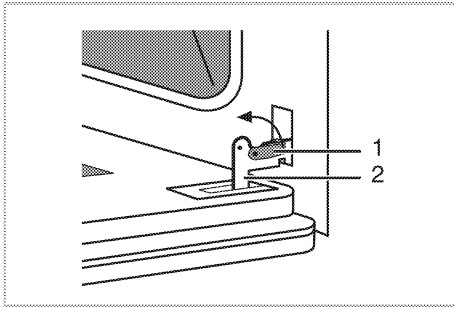

- 1 Hinged shackles
- 2 Hinge

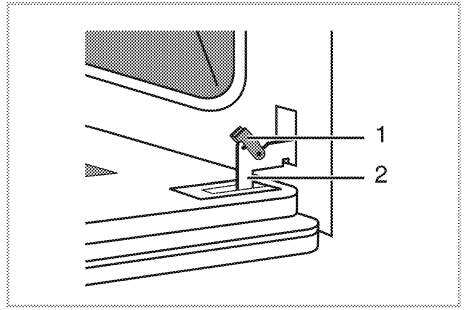

- 3. Put oven door in a slightly sloping position.
 - 4. Lift the oven door to the front with both hands.
- Install oven door again in reverse order after cleaning.

8 Troubleshooting

-  Risk of electric shock, short circuit or fire by unprofessional repairs!
Repairs on the appliance must be carried out by an approved service centre.

- It is normal that steam escapes during operation.
- When the metal parts are heated, they may expand and cause noise.

Before you call the service, please check the following points.

Normal operating conditions

- Smoke and smell may emit for a couple of hours during the first operation.

Electrical equipment

Malfunction/problem	Possible cause	Advice/remedy
The appliance does not work.	The mains fuse is defective or has tripped.	Check fuses in the fuse box. If necessary, replace or reset them.
Oven does not heat.	Function knob and/thermostat knob are not set.	Set function knob and thermostat knob.
	If the appliance has a timer, the timer may not be set.	Set the time.
	No power.	Check mains supply and fuse box.

If the problem has not been solved:

1. Separate unit from the mains supply (deactivate or unscrew fuse).
2. Call the appropriate telephone number for your area as shown in

the Guarantee and Service section of this user manual.



Do not attempt to repair the appliance yourself. There are no customer service items inside the appliance.

9 Guarantee and Service

Your Beko product is guaranteed against the cost of breakdown repairs : Freestanding appliances : 1 year
Built-in appliances : 2 year
from the date of the original purchase.

What is covered?

- All repairs necessary as a result of faulty materials, defective components or manufacturing defect.
- The cost of all functional replacement parts.
- The labour costs of a Beko approved repairer to carry out the repair.

What is not covered?

- Transit or delivery damage
- Accidental damage
- Misuse, or abuse.
- Cabinet or appearance parts, including knobs and flaps
- Accessory items, including ice trays, scrapers, cutlery baskets,
- Repairs required as a result of unauthorised repairs or inexperienced installation that fails to meet the requirements contained in the user instruction book.

Repairs to products used on commercial or non-residential household premises.

Important notes.

- The product is guaranteed for domestic household use only.
- The guarantee will be void if the product is installed or used in commercial or non-residential household premises.
- The product must be correctly installed, located and operated in accordance with the instructions contained in the User Instructions Booklet provided.
- Professional Installation by a qualified plumber/electrical appliance installer is recommended for all Washing & Dishwashing Machines and Electric Cookers
- Gas Cookers must only be installed by a Gas Safe (or BORD GAIS) registered Gas Installer.
- The guarantee is given only within the boundaries of the United Kingdom.
- The guarantee is not transferable if the product is resold.
- Beko plc disclaims any liability for incidental or consequential damages.
- The guarantee does not in anyway diminish your statutory or legal rights.

HOW TO OBTAIN SERVICE UNDER THE MANUFACTURERS GUARANTEE

Please keep your purchase receipt or other proof of purchase in a safe place; you will need to have it should the product require attention in the guarantee period

You should also complete the details below; it will help us assist you quicker when requesting service. (The model number is printed on the Instruction Booklet)

Model Number: _____ Purchased From: _____ Date of purchase: _____

For service under guarantee simply telephone the appropriate number below

LOCATION

TELEPHONE

UK Mainland & Northern Ireland

Fridges & Freezers	0845 600 4903
Electric Cookers	0845 600 4902
Gas & Dual Fuel Cookers	0845 600 4905
Washing Machines & Dishwashers	0845 600 4906

Republic of Ireland

All Refrigeration, Cooking, Washing & Dishwashing Machines	01 862 3411
--	-------------

Before requesting service please check the trouble-shooting guide in the Operating Instructions as a charge may be levied where no fault is found even though your product may still be under guarantee.

Service once the manufacturers guarantee has expired.

If you have purchased an extended guarantee please refer to the instructions contained within the extended guarantee agreement document. Otherwise please call the above numbers where service can be obtained at a charge.

Should you experience any difficulty in obtaining service please call the

Beko Customer Help-Line on 0845 600 4911

Beko House, Caxton Way, Watford, Herts, WD18 8UF, Tel: 0845 600 4911

Beko plc
Beko House
Caxton Way
Watford
Herts WD18 8UF
Tel: 0845 600 4911

Printed in Turkey
Part no: 485.9212.05
Rev: AA/ 24.11.2010