

Double Oven User Manual

BDVC675NTW

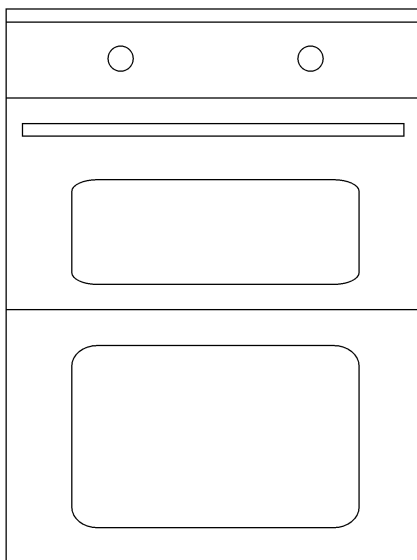

Please read this user manual first!

Dear Customer,

Thank you for purchasing this Beko product. We hope that you get the best results from your product which has been manufactured with high quality and state-of-the-art technology. Therefore, please read this entire user manual and all other accompanying documents carefully before using the product and keep it as a reference for future use. If you handover the product to someone else, give the user manual as well. Follow all warnings and information in the user manual.

Remember that this user manual is also applicable for several other models. Differences between models will be identified in the manual.

Explanation of symbols

Throughout this user manual the following symbols are used:

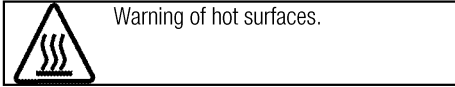
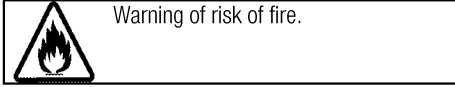
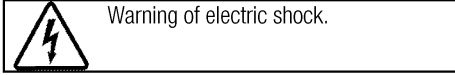
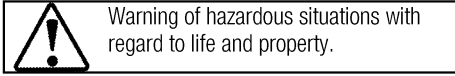
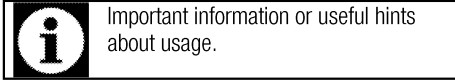

Arçelik A.Ş.
Karaağaç caddesi No:2-6
34445 Sütlüce/Istanbul/TURKEY
Made in TURKEY



This product was manufactured using the latest technology in environmentally friendly conditions.

TABLE OF CONTENTS

1 Important instructions and warnings for safety and environment 4

General safety	4
Electrical safety	4
Product safety	5
Intended use	7
Safety for children.....	7
Disposing of the old product	7
Package information	7

2 General information 8

Overview	8
Package contents	9
Technical specifications	10

3 Installation 11

Before installation	11
Installation and connection	12
Future Transportation.....	13

4 Preparation 14

Tips for saving energy	14
Initial use	14
Time setting	14
First cleaning of the appliance	15
Initial heating.....	15

5 How to use the hob 16

General information about cooking	16
Using the hobs.....	16

6 How to operate the oven 18

General information on baking, roasting and grilling	18
How to operate the electric oven	18
Operating modes.....	18
Using the oven clock	19
Using the keylock.....	19
Using the clock as an alarm	20
Cooking times table.....	21
How to operate the top oven	22
Cooking times table.....	22
How to operate the top grill.....	23
Top oven cooking times table for grilling	24

7 Maintenance and care 25

General information.....	25
Cleaning the hob	25
Cleaning the control panel	25
Cleaning the oven	25
Removing the oven door	26
Removing the door inner glass	26
Replacing the oven lamp.....	27

8 Troubleshooting 28

9 Guarantee and Service 29

1 Important instructions and warnings for safety and environment

This section contains safety instructions that will help protect from risk of personal injury or property damage. Failure to follow these instructions shall void any warranty.

General safety

- This appliance can be used by children aged from 8 years and above and persons with reduced physical, sensory or mental capabilities or lack of experience and knowledge if they have been given supervision or instruction concerning use of the appliance in a safe way and understand the hazards involved.

Children shall not play with the appliance. Cleaning and user maintenance shall not be made by children without supervision.

- Never place the product on a carpet-covered floor. Otherwise, lack of airflow beneath the product will cause electrical parts to overheat. This will cause problems with your product.
- Installation and repair procedures must always be performed by Authorized Service Agents. The manufacturer shall not be held responsible for damages arising from procedures carried out by unauthorized persons which may also void the warranty. Before

installation, read the instructions carefully.

- Do not operate the product if it is defective or has any visible damage.
- Ensure that the product function knobs are switched off after every use.

Electrical safety

- If the product has a failure, it should not be operated unless it is repaired by an Authorized Service Agent. There is the risk of electric shock!
- Only connect the product to a grounded outlet/line with the voltage and protection as specified in the “Technical specifications”. Have the grounding installation made by a qualified electrician while using the product with or without a transformer. Our company shall not be liable for any problems arising due to the product not being earthed in accordance with the local regulations.
- Never wash the product by spreading or pouring water onto it! There is the risk of electric shock!
- The product must be disconnected during installation, maintenance, cleaning and repairing procedures.
- If the power connection cable for the product is damaged, it must be

replaced by the manufacturer, its service agent or similarly qualified persons in order to avoid a hazard.

- Only use the connection cable specified in the “Technical specifications”.
- The appliance must be installed so that it can be completely disconnected from the mains supply. The separation must be provided by a switch built into the fixed electrical installation, according to construction regulations.
- Rear surface of the oven gets hot when it is in use. Make sure that the electrical connection does not contact the rear surface; otherwise, connections can get damaged.
- Do not trap the mains cable between the oven door and frame and do not route it over hot surfaces. Otherwise, cable insulation may melt and cause fire as a result of short circuit.
- Any work on electrical equipment and systems should only be carried out by authorized and qualified persons.
- In case of any damage, switch off the product and disconnect it from the mains. To do this, turn off the fuse at home.
- Make sure that fuse rating is compatible with the product.

Product safety

- The appliance and its accessible parts become hot during use. Care should be taken to avoid touching heating elements. Children less than 8 years of age shall be kept away unless continuously supervised.
- Never use the product when your judgment or coordination is impaired by the use of alcohol and/or drugs.
- Be careful when using alcoholic drinks in your dishes. Alcohol evaporates at high temperatures and may cause fire since it can ignite when it comes into contact with hot surfaces.
- Do not place any flammable materials close to the product as the sides may become hot during use.
- During use the appliance becomes hot. Care should be taken to avoid touching heating elements inside the oven.
- Keep all ventilation slots clear of obstructions.
- Do not heat closed tins and glass jars in the oven. The pressure that would build-up in the tin/jar may cause it to burst.
- Do not place baking trays, dishes or aluminium foil directly onto the bottom of the oven. The heat accumulation might damage the bottom of the oven.

- Do not use harsh abrasive cleaners or sharp metal scrapers to clean the oven door glass since they can scratch the surface, which may result in shattering of the glass.
- Do not use steam cleaners to clean the appliance as this may cause an electric shock.
- Placing the wire shelf and tray onto the wire racks properly
It is important to place the wire shelf and/or tray onto the rack properly. Slide the wire shelf or tray between 2 rails and make sure that it is balanced before placing food on it (Please see the following figure).

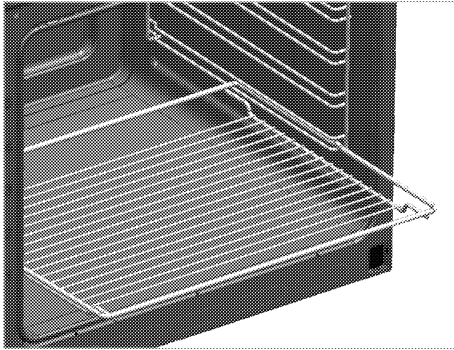

- Do not use the product if the front door glass removed or cracked.
- Do not use the oven handle to hang towels for drying. Do not hang up towel, gloves, or similar textile products when the grill function is at open door.
- Always use heat resistant oven gloves when putting in or removing dishes into/from the hot oven.

- Ensure that the appliance is switched off before replacing the lamp to avoid the possibility of electric shock.
- Unattended cooking on a hob with fat or oil can be dangerous and may result in fire. NEVER try to extinguish a fire with water, but switch off the appliance and then cover flame e.g. with a lid or a fire blanket.
- Danger of fire: Do not store items on the cooking surfaces.
- If the surface is cracked, switch off the appliance to avoid the possibility of electric shock.
- The appliance is not intended to be operated by means of an external timer or separate remote-control system.
- Vapour pressure that build up due to the moisture on the hob surface or at the bottom of the pot can cause the pot to move. Therefore, make sure that the oven surface and bottom of the pots are always dry.
- Use only hob guards designed by the manufacturer of the cooking appliance or indicated by the manufacturer of the appliance in the instructions for use as suitable or hob guards incorporated in the appliance. The use of inappropriate guards can cause accidents.

Prevention against possible fire risk!

- Ensure all electrical connections are secure and tight to prevent risk of arcing.
- Do not use damaged cables or extension cables.
- Ensure liquid or moisture is not accessible to the electrical connection point.

Intended use

- This product is designed for domestic use. Commercial use will void the guarantee.
- This appliance is for cooking purposes only. It must not be used for other purposes, for example room heating.
- This product should not be used for warming the plates under the grill, drying towels, dish cloths etc. by hanging them on the oven door handles. This product should also not be used for room heating purposes.
- The manufacturer shall not be liable for any damage caused by improper use or handling errors.
- The oven can be used for defrosting, baking, roasting and grilling food.

Safety for children

- Accessible parts may become hot during use. Young children should be kept away.
- The packaging materials will be dangerous for children. Keep the packaging materials away from children. Please dispose of all parts

of the packaging according to environmental standards.

- Electrical products are dangerous to children. Keep children away from the product when it is operating and do not allow them to play with the product.
- Do not place any items above the appliance that children may reach for.
- When the door is open, do not load any heavy object on it and do not allow children to sit on it. It may overturn or door hinges may get damaged.

Disposing of the old product

Compliance with the WEEE Directive and Disposing of the Waste Product:



This product complies with EU WEEE Directive (2012/19/EU). This product bears a classification symbol for waste electrical and electronic equipment (WEEE).

This product has been manufactured with high quality parts and materials which can be reused and are suitable for recycling. Do not dispose of the waste product with normal domestic and other wastes at the end of its service life. Take it to the collection center for the recycling of electrical and electronic equipment. Please consult your local authorities to learn about these collection centers.

Compliance with RoHS Directive:

The product you have purchased complies with EU RoHS Directive (2011/65/EU). It does not contain harmful and prohibited materials specified in the Directive.

Package information

- Packaging materials of the product are manufactured from recyclable materials in accordance with our National Environment Regulations. Do not dispose of the packaging materials together with the domestic or other wastes. Take them to the packaging material collection points designated by the local authorities.

2 General information

Overview

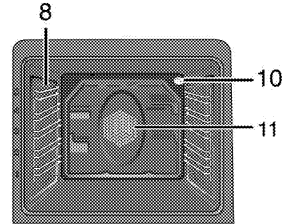
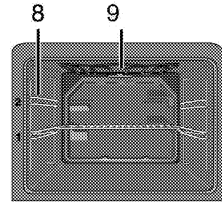
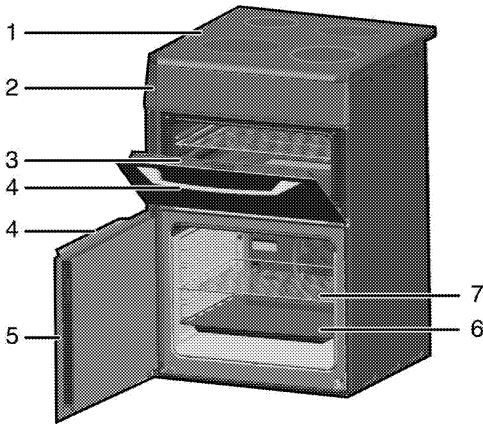

- | | | | |
|---|----------------|----|--------------------------------|
| 1 | Burner plate | 7 | Wire shelf |
| 2 | Control panel | 8 | Shelf positions |
| 3 | Top oven door | 9 | Grill heating element |
| 4 | Handle | 10 | Lamp |
| 5 | Main oven door | 11 | Fan motor (behind steel plate) |
| 6 | Tray | | |

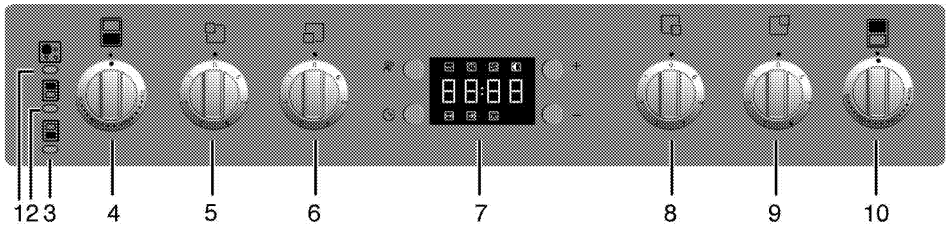

- | | | | |
|---|----------------------------------------|----|------------------------------------------|
| 1 | Warning lamp | 6 | Single-circuit cooking plate Front left |
| 2 | Thermostat lamp for top oven | 7 | Digital timer |
| 3 | Thermostat lamp for main oven | 8 | Single-circuit cooking plate Front right |
| 4 | Main oven function knob | 9 | Single-circuit cooking plate Rear right |
| 5 | Single-circuit cooking plate Rear left | 10 | Top oven function knob |

Package contents



Accessories supplied can vary depending on the product model. Not every accessory described in the user manual may exist on your product.

1. **User manual**

2. **Oven tray**

Used for pastries, frozen foods and big roasts.

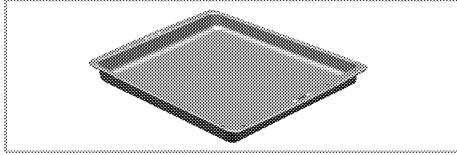

3. **Wire Shelf**

Used for roasting and for placing the food to be baked, roasted or cooked in casserole dishes to the desired rack.

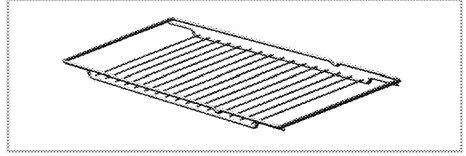

4. **Small wire shelf**

It is placed into the tray (if supplied) in order to collect the dripping fat while grilling so that the oven is kept clean.

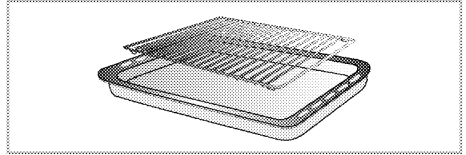

Technical specifications

GENERAL	
External dimensions (height / width / depth)	900 mm/600 mm/600 mm
Voltage / frequency	220-240 V ~ 50 Hz
Total power consumption	10 kW
Fuse	min. 32 A
Cable type / section	H05VV-FG 3 x 4 mm ² or equivalent
HOB	
Burners	
Rear left	Single-circuit cooking plate
Dimension	140 mm
Power	1200 W
Front left	Single-circuit cooking plate
Dimension	180 mm
Power	1700 W
Front right	Single-circuit cooking plate
Dimension	140 mm
Power	1200 W
Rear right	Single-circuit cooking plate
Dimension	180 mm
Power	1700 W
OVEN/GRILL	
Top oven	Conventional oven
Grill power consumption	2.2 kW
Main oven	Fan oven
Inner lamp	15–25 W

Basics: Information on the energy label of electrical ovens is given in accordance with the EN 60350-1 / IEC 60350-1 standard. Those values are determined under standard load with bottom-top heater or fan assisted heating (if any) functions.

Energy efficiency class is determined in accordance with the following prioritization depending on whether the relevant functions exist on the product or not. 1-Cooking with eco-fan, 2- Turbo slow cooking, 3- Turbo cooking, 4- Fan assisted bottom/top heating, 5-Top and bottom heating.



Technical specifications may be changed without prior notice to improve the quality of the product.



Figures in this manual are schematic and may not exactly match your product.



Values stated on the product labels or in the documentation accompanying it are obtained in laboratory conditions in accordance with relevant standards. Depending on operational and environmental conditions of the product, these values may vary.

3 Installation

Product must be installed by a qualified person in accordance with the regulations in force. The manufacturer shall not be held responsible for damages arising from procedures carried out by unauthorized persons which may also void the warranty.



Preparation of location and electrical installation for the product is under customer's responsibility.



DANGER:

The product must be installed in accordance with all local electrical regulations.



DANGER:

Prior to installation, visually check if the product has any defects on it. If so, do not have it installed.

Damaged products cause risks for your safety.

Before installation

To ensure that critical air gaps are maintained under the appliance, we recommend that this appliance is mounted on a solid base and that the feet do not sink into any carpet or soft flooring.

The kitchen floor must be able to carry the weight of the appliance plus the additional weight of cookware and bakeware and food.

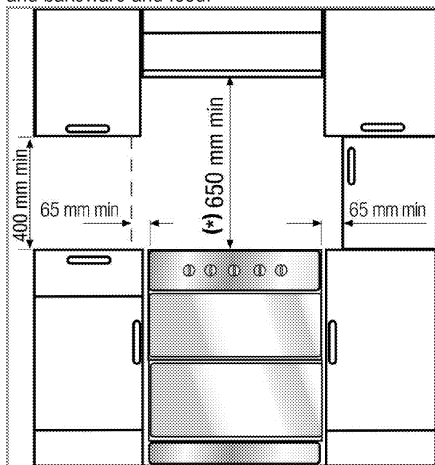

- It can be used with cabinets on either side but in order to have a minimum distance of 400mm above hotplate level allow a side clearance of 65mm between the appliance and any wall, partition or tall cupboard.

- It can also be used in a free standing position. Allow a minimum distance of 650 mm above the hob surface.
- (*) If a cooker hood is to be installed above the cooker, refer to cooker hood manufacturer' instructions regarding installation height (min 650 mm).
- Movement of your appliance is most easily achieved by lifting the front as follows and pulling towards. Open the top oven door and the bottom oven door sufficiently to allow a comfortable grip on the underside front edge of the oven roofs. While gripping, it should be avoided to damage any grill elements or oven interior furniture.
- The appliance corresponds to device class 1, i.e. it may be placed with the rear and **one** side to kitchen walls, kitchen furniture or equipment of any size. The kitchen furniture or equipment on the **other** side may only be of the same size or smaller.
- Any kitchen furniture next to the appliance must be heat-resistant (100 °C min.).

Safety chain

The appliance must be secured against overbalancing by using the supplied two safety chains on your oven.

Fasten hook (1) by using a proper peg to the kitchen wall (6) and connect safety chain (3) to the hook via the locking mechanism (2).

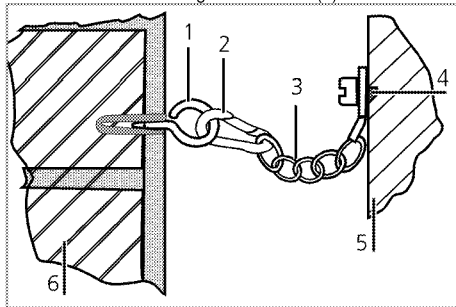

- 1 Stability hook
- 2 Locking mechanism
- 3 Safety chain (supplied and mounted to oven)
- 4 Firmly fix chain to cooker rear
- 5 Rear of cooker
- 6 Kitchen wall



Stability chain to be as short as practicable to avoid oven tilting forward and diagonal to avoid oven side tilting.

Installation and connection

Product can only be installed and connected in accordance with the statutory installation rules.



Do not install the product next to refrigerators or freezers. The heat emitted by the product will increase the energy consumption of cooling appliances.

- Carry the product with at least two persons.
- Product must be placed directly on the floor. It must not be placed onto a base or a pedestal.



Do not use the door and/or handle to carry or move the product. The door, handle or hinges get damaged.

Electrical connection

Connect the product to a grounded outlet/line protected by a fuse of suitable capacity as stated in the "Technical specifications" table. Have the grounding installation made by a qualified electrician while using the product with or without a transformer. Our company shall not be liable for any damages that will arise due to using the product without a grounding installation in accordance with the local regulations.



DANGER:

The product must be connected to the mains supply only by an authorised and qualified person. The product's warranty period starts only after correct installation. Manufacturer shall not be held responsible for damages arising from procedures carried out by unauthorised persons.



DANGER:

The power cable must not be clamped, bent or trapped or come into contact with hot parts of the product. A damaged power cable must be replaced by a qualified electrician. Otherwise, there is risk of electric shock, short circuit or fire!

The mains supply data must correspond to the data specified on the type label of the product. The rating plate is either seen when the door or the lower cover is opened or it is located at the rear wall of the unit depending on the unit type.

Power cable of your product must comply with the values in "Technical specifications" table.



DANGER:

Before starting any work on the electrical installation, disconnect the product from the mains supply. There is the risk of electric shock!

Connecting the power cable

1. If a power cable is not supplied together with your product, a power cable that you would select from the table in accordance with the electrical installation at your home must be connected to your product by following the instructions in cable diagram.

This product must only be connected by a qualified electrician such as a technician from the local electricity company or NICEIC registered contractor to a suitable double-pole control unit with a minimum contact clearance of 3 mm in all poles. This control unit must be installed in accordance with the IEE directives. Failure to obey this instruction may cause operational problems and invalidate the product warranty.

This product must only be installed by a qualified electrician eg local electricity company or NICEIC registered contractor to a suitable double-pole control unit with a minimum contact clearance of 3mm in all poles and with a minimum rating please consider technical data table, *Technical specifications, page 10* which should be fitted adjacent to (but not above) the cooker in accordance with IEE regulations. Failure to observe this instruction may result in operational problems and invalidation of the product warranty.



Additional protection by a residual current circuit breaker is recommended.

2. The cable must have conductors of sufficiently high cross sectional area to prevent overheating and deterioration.

The mains cable must conform to BS6004. This appliance must be earthed.

The mains cable must pass through the cable clamp. The mains cable should be routed away from the appliance and in particular ventilation slots, the vent outlet and should not be obstructed when pushed in to position between the appliance and the wall and/or cabinets.

3. Open the terminal block cover with a screwdriver.
4. Insert the power cable through the cable clamp below the terminal and secure it to the main body with the integrated screw on cable clamping component.

5. Connect the cables according to the supplied diagram.

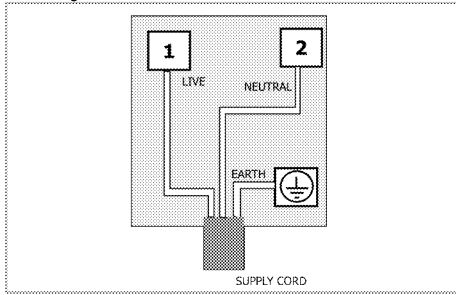

6. After completing the wire connections, close the terminal block cover.
7. Route the power cable so that it will not contact the product and get squeezed between the product and the wall.



Power cable must not be longer than 2m because of safety reasons.

- Push the product towards the kitchen wall.
- **Adjusting the feet of oven**
Vibrations during use may cause cooking vessels to move. This dangerous situation can be avoided if the product is level and balanced. For your own safety please ensure the product is level by adjusting the four feet at the bottom by turning left or right and align level with the work top.

For products with cooling fan

The cooling fan cools both the control panel and the front of the appliance.



Cooling fan continues to run for up to 20-30 minutes (approx.) even after the oven is turned off.

Final check

1. Reconnect the product to the mains.
2. Check electrical functions.

Future Transportation

- Keep the product's original carton and transport the product in it. Follow the instructions on the carton. If you do not have the original carton, pack the product in bubble wrap or thick cardboard and tape it securely.

- To prevent the wire grill and tray inside the oven from damaging the oven door, place a strip of cardboard onto the inside of the oven door that lines up with the position of the trays. Tape the oven door to the side walls.
- Do not use the door or handle to lift or move the product.



Do not place any objects onto the product and move it in upright position.



Check the general appearance of your product for any damages that might have occurred during transportation.

4 Preparation

Tips for saving energy

The following information will help you to use your appliance in an ecological way, and to save energy:

- Use dark coloured or enamel coated cookware in the oven since the heat transmission will be better.
- While cooking your dishes, perform a preheating operation if it is advised in the user manual or cooking instructions.
- Do not open the door of the oven frequently during cooking.
- Try to cook more than one dish in the oven at the same time whenever possible. You can cook by placing two cooking vessels onto the wire shelf.
- Cook more than one dish one after another. The oven will already be hot.
- You can save energy by switching off your oven a few minutes before the end of the cooking time. Do not open the oven door.
- Defrost frozen dishes before cooking them.
- Use pots/pans with cover for cooking. If there is no cover, energy consumption may increase 4 times.
- Select the burner which is suitable for the bottom size of the pot to be used. Always select the correct pot size for your dishes. Larger pots require more energy.
- Pay attention to use flat bottom pots when cooking with electric hobs. Pots with thick bottom will provide a better heat conduction. You can obtain energy savings up to 1/3.
- Vessels and pots must be compatible with the cooking zones. Bottom of the vessels or pots must not be smaller than the hotplate.
- Keep the cooking zones and bottom of the pots clean. Dirt will decrease the heat conduction between the cooking zone and bottom of the pot.
- For long cookings, turn off the cooking zone 5 or 10 minutes before the end of cooking time. You can obtain energy savings up to 20% by using the residual heat.

Initial use

Time setting



While making any adjustment, related symbols on the clock will flash.

Press „-“ or „+“ (5/6) keys to set the time after the oven is energized for the first time.

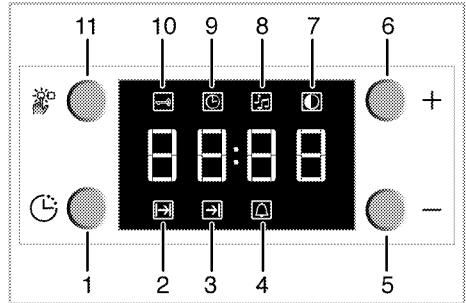

- 1 Program key
- 2 Cooking time
- 3 End of cooking time
- 4 Alarm symbol
- 5 Minus key
- 6 Plus key
- 7 Screen brightness setting
- 8 Alarm volume
- 9 Current time
- 10 Keylock
- 11 Adjustment key

After setting the time, you can start and end the cooking by selecting the desired position with temperature button and function button.



If the current time is not set, time setting will start increasing/moving up from **12:00**. Clock symbol '9' will be displayed to indicate that the current time has not been set. This symbol will disappear once the time is set.



Current time settings are cancelled in case of power failure. It needs to be readjusted.

Changing the time of the day

To change the time of the day you have previously set:

1. Press (11) key to activate current time symbol '9'.
2. Press „-“ or „+“ (5/6) keys to set the current time.

Changing screen brightness adjustment

1. Press (11) key to activate screen brightness symbol '7' for screen brightness adjustment.
2. Press '- ' or '+ ' (5/6) keys to set the desired brightness.
» Selected brightness level will appear as **d-01**, **d-02** or **d-03** on the display.

First cleaning of the appliance



The surface might get damaged by some detergents or cleaning materials. Do not use aggressive detergents, cleaning powders/creams or any sharp objects during cleaning. Do not use harsh abrasive cleaners or sharp metal scrapers to clean the oven door glass since they can scratch the surface, which may result in shattering of the glass.

1. Remove all packaging materials.
2. Wipe the surfaces of the appliance with a damp cloth or sponge and dry with a cloth.

Initial heating

Heat up the product for about 30 minutes and then switch it off. Thus, any production residues or layers will be burnt off and removed.



WARNING

Hot surfaces cause burns! Product may be hot when it is in use. Never touch the hot burners, inner sections of the oven, heaters and etc. Keep children away. Always use heat resistant oven gloves when putting in or removing dishes into/from the hot oven.

Electric oven

1. Take all baking trays and the wire grill out of the oven.
2. Close the oven door.
3. Select the highest oven power; See *How to operate the electric oven, page 18*.
4. Operate the oven for about 30 minutes.
5. Turn off your oven; See *How to operate the electric oven, page 18*

Grill oven

1. Take all baking trays and the wire grill out of the oven.
2. Close the oven door.
3. Select the highest oven power for grill oven; see .
4. Operate the grill about 30 minutes.
5. Turn off your grill; see



Smoke and smell may emit for a couple of hours during the initial operation. This is quite normal. Ensure that the room is well ventilated to remove the smoke and smell. Avoid directly inhaling the smoke and the smell that emits.

5 How to use the hob

General information about cooking



Never fill the pan with oil more than one third of it. Do not leave the hob unattended when heating oil. Overheated oils bring risk of fire. **Never attempt to extinguish a possible fire with water!** When oil catches fire, cover it with a fire blanket or damp cloth. Turn off the hob if it is safe to do so and call the fire department.

- Before frying foods, always dry them well and gently place into the hot oil. Ensure complete thawing of frozen foods before frying.
- Do not cover the vessel you use when heating oil.
- Place the pans and saucepans in a manner so that their handles are not over the hob to prevent heating of the handles. Do not place unbalanced and easily tilting vessels on the hob.
- Do not place empty vessels and saucepans on cooking zones that are switched on. They might get damaged.
- Operating a cooking zone without a vessel or saucepan on it will cause damage to the product. Turn off the cooking zones after the cooking is complete.
- As the surface of the product can be hot, do not put plastic and aluminum vessels on it. Clean any melted such materials on the surface immediately. Such vessels should not be used to keep foods either.
- Use flat bottomed saucepans or vessels only.
- Put appropriate amount of food in saucepans and pans. Thus, you will not have to make any unnecessary cleaning by preventing the dishes from overflowing. Do not put covers of saucepans or pans on cooking zones. Place the saucepans in a manner so that they are centered on the cooking zone. When you want to move the saucepan onto another cooking zone, lift and place it onto the cooking zone you want instead of sliding it.

Tips about glass ceramic hobs

- Glass ceramic surface is heatproof and is not affected by big temperature differences.

- Do not use the glass ceramic surface as a place of storage or as a cutting board.
- Use only the saucepans and pans with machined bottoms. Sharp edges create scratches on the surface.
- Do not use aluminum vessels and saucepans. Aluminum damages the glass ceramic surface.

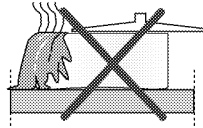

Spills may damage the glass ceramic surface and cause fire.

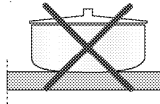

Do not use vessels with concave or convex bottoms.

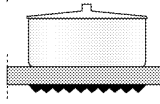

Use only the saucepans and pans with flat bottoms. They ensure easier heat transfer. If the diameter of the saucepan is too small, energy will be wasted.

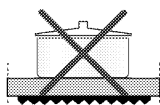

Using the hobs

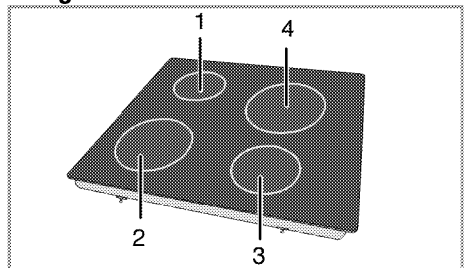

List of advised diameter of pots to be used on related burners.

- 1 Single-circuit cooking plate
- 2 Single-circuit cooking plate
- 3 Single-circuit cooking plate
- 4 Single-circuit cooking plate

**DANGER:**

Do not allow any object to drop on the hob. Even small objects such as a saltshaker may damage the hob.

Do not use cracked hobs. Water may leak through these cracks and cause short circuit. In case of any kind of damage on the surface (eg., visible cracks), switch off the product immediately to minimize the risk of electric shock.

Turning on the ceramic plates

The hob control knobs are used for operating the plates. To obtain the desired cooking power, turn the hob control knobs to the corresponding level.

Cooking level	1	2 — 3	4 — 6
	warming	stewing, simmering	boiling

Turning off the ceramic plates

Turn the plate knob to OFF (upper) position.



Quick heating glass-ceramic hobs emit a bright light when they are switched on. Do not stare at the bright light.

6 How to operate the oven

General information on baking, roasting and grilling



WARNING

Hot surfaces cause burns!
Product may be hot when it is in use. Never touch the hot burners, inner sections of the oven, heaters and etc. Keep children away. Always use heat resistant oven gloves when putting in or removing dishes into/from the hot oven.



DANGER:

Be careful when opening the oven door as steam may escape.
Exiting steam can scald your hands, face and/or eyes.

Tips for baking

- Use non-sticky coated appropriate metal plates or aluminum vessels or heat-resistant silicone moulds.
- Make best use of the space on the rack.
- Place the baking mould in the middle of the shelf.
- Select the correct rack position before turning the oven or grill on. Do not change the rack position when the oven is hot.
- Keep the oven door closed.

Tips for roasting

- Treating whole chicken, turkey and large piece of meat with dressings such as lemon juice and black pepper before cooking will increase the cooking performance.
- It takes about 15 to 30 minutes longer to roast meat with bones when compared to roasting the same size of meat without bones.
- Each centimeter of meat thickness requires approximately 4 to 5 minutes of cooking time.
- Let meat rest in the oven for about 10 minutes after the cooking time is over. The juice is better distributed all over the roast and does not run out when the meat is cut.
- Fish should be placed on the middle or lower rack in a heat-resistant plate.

How to operate the electric oven

Product is equipped with two ovens. Overview section indicates the relevant knobs for each oven.

How to operate the main oven

Select temperature and operating mode

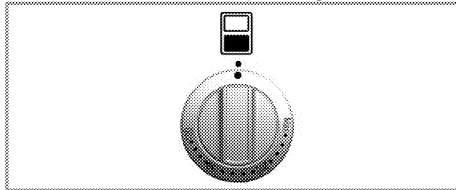

1. Set the Function knob to the desired temperature.
» Oven heats up to the adjusted temperature and maintains it. During heating, temperature lamp stays on.

Switching off the electric oven

Turn the Function knob to Off (top) position.

Rack positions (For models with wire shelf)

It is important to place the wire shelf onto the side rack correctly. Wire shelf must be inserted between the side racks as illustrated in the figure.

Do not let the wire shelf stand against the rear wall of the oven. Slide your wire shelf to the front section of the rack and settle it with the help of the door in order to obtain a good grill performance.

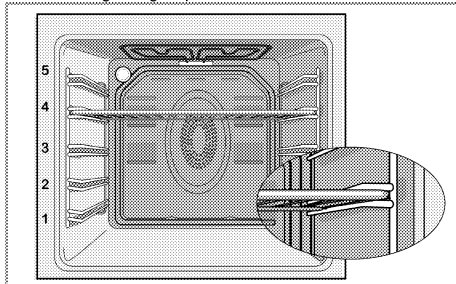

Operating modes



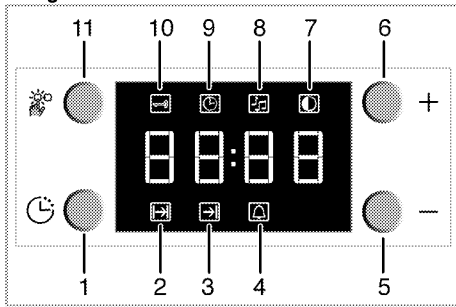

All functions in your oven (including the main oven) are described in this section.

The order of operating modes shown here may be different from the arrangement on your product.

Using the oven clock



- 1 Program key
- 2 Cooking time
- 3 End of cooking time
- 4 Alarm symbol
- 5 Minus key
- 6 Plus key
- 7 Screen brightness setting
- 8 Alarm volume
- 9 Current time
- 10 Keylock
- 11 Adjustment key

	Maximum time that can be set for end of cooking is 5 hours 59 minutes. Program will be cancelled in case of power failure. You must reprogram the oven.
	While making any adjustments, related symbols will flash on the display. You must wait for a short time for the settings to take effect.
	If no cooking setting is made, time of the day cannot be set.
	Cooking time will be displayed once the cooking starts.

Cooking by specifying the cooking time:

You can set the oven so that it will stop at the end of the specified time by setting the cooking time on the clock.

1. To adjust the cooking time, Press Program key (1) and activate the Cooking Time symbol (2).
2. Press '-' / '+' (5/6) keys to set the cooking time.
» Once the Cooking Time is set, Cooking symbol will be displayed continuously.

If you want to set the end of cooking time to a later time:

After setting the cooking time on the clock, you can set the end of cooking time to a later time.

1. To adjust the cooking time, press Program key (1) and activate the Cooking Time symbol (2).
2. Adjust the cooking time with Minus (5) and Plus (6) keys.
» Cooking Time symbol remains lit (displayed continuously) after setting the cooking time.
3. To set the End of Cooking Time, Press Program key (1) and activate the Cooking Time symbol (3).
4. Press - (5) and + (6) keys to set the end of cooking time.
» Once the End of Cooking Time is set, End of Cooking symbol and Cooking symbol will be displayed continuously. The End of Cooking Time symbol (3) will disappear as soon as the cooking starts.
5. Put your dish into the oven.
6. Select operation mode and temperature.
» Oven timer automatically calculates the startup time for cooking by using the end of cooking time and the cooking period you have set. Selected operation mode is activated when the startup time of cooking has come and the oven is heated up to the set temperature. It maintains this temperature until the end of cooking time.
7. After the cooking process is completed, "End" appears on the displayed and the alarm will sound.
8. Alarm signal will sound for 2 minutes. To stop the alarm signal, just press any key. Alarm will be silenced and current time will be displayed.

	If you mute the alarm by pressing any key, the oven will restart operating. If you press any button at the end of the alarm period, the oven will restart operating.
-----------------------------------------------------------------------------------	-------------------------------------------------------------------------------------------------------------------------------------------------------------------------

9. Turn off the oven with the Temperature knob and Function knob.

Using the keylock

Activating the keylock

You can prevent oven from being used by activating the Keylock function.

1. Press the key (11) to activate Keylock symbol (10).
» "OFF" will appear on the display.
2. Press '+' key (6) to activate the keylock.
» Once the keylock is activated, "On" appears on the display and the Keylock symbol (10) remains lit.

	When the Keylock function is activated, control panel buttons except for the key (11) cannot be used.
-------------------------------------------------------------------------------------	-------------------------------------------------------------------------------------------------------

Deactivating the keylock

1. Press Adjustment key (11) to activate Keylock symbol (10).
» "On" will appear on the display.
2. Press '-' (5) to deactivate the keylock.
» "OFF" will be displayed once the keylock is deactivated.

Using the clock as an alarm

The alarm clock has no influence on the functions of the oven. It is only used as a warning. For example, this is useful when you want to turn food in the oven at a certain point of time. Alarm clock will give a signal once the time you set is over.

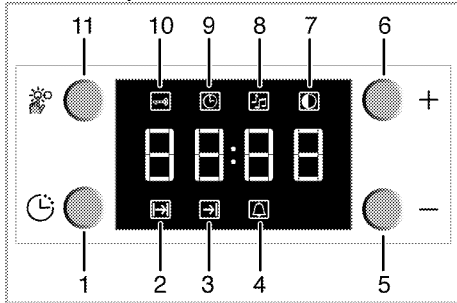

- 1 Program key
- 2 Cooking time
- 3 End of cooking time
- 4 Alarm symbol
- 5 Minus key
- 6 Plus key
- 7 Screen brightness setting
- 8 Alarm volume
- 9 Current time
- 10 Keylock
- 11 Adjustment key

Setting the alarm clock

1. Press Program key (1) to activate the alarm time symbol (4).



Maximum alarm time can be 23 hours and 59 minutes.

2. Adjust the alarm time using „+“ / „-“ (5/6) keys.
» Alarm symbol will remain lit and the alarm time will appear on the display once the alarm time is set.
3. At the end of the alarm time, Alarm Time symbol (4) will start flashing and the alarm signal is heard.

Turning off the alarm

1. To stop the alarm, just press any key.
» Alarm will be silenced and current time will be displayed.

If you want to cancel the alarm:

1. To reset the alarm time, press Program key (1) to activate the alarm time symbol (4).
2. Press and hold the '-' (5) key until "00:00" is displayed.



Alarm time will be displayed. If the alarm time and cooking time are set concurrently, shortest time will be displayed.

Changing alarm tone

1. Press Setting key (11) to activate the Alarm Tone symbol (8).
2. Adjust the desired tone using „+“ / „-“ (5/6) keys.
» Selected alarm tone will appear as "b-01", "b-02" or "b-03" on the display.

Cooking times table



The timings in this chart are meant as a guide. Timings may vary due to temperature of food, thickness, type and your own preference of cooking.

Baking and roasting



1st rack of the oven is the **bottom** rack.

Dish	Cooking level number		Rack position	Temperature (°C)	Cooking time (approx. in min.)
Cakes in tray*	One level		1	175	30 ... 40
Cakes in mould*	One level		1	175	50 ... 60
Cakes in cooking paper*	One level		1	175	25 ... 35
Sponge cake*	One level		1	200	8 ... 15
Cookies*	One level		1	175	25 ... 30
	2 levels		1 - 3	170 ... 180	35 ... 45
Dough pastry*	One level		1	200	35 ... 45
Rich pastry*	One level		1	190	25 ... 35
	2 levels		1 - 3	190	35 ... 45
Leaven*	One level		1	200	35 ... 45
Lasagna*	One level		1	200	30 ... 40
Beef steak (whole) / Roast	One level		1	25 min. 250/max, then 180 ... 190	100 ... 120
Leg of Lamb (casserole)	One level		1	25 min. 220 then 180 ... 190	70 ... 90
Roasted chicken	One level		1	15 min. 250/max, then 190	55 ... 65
Turkey (Sliced)	One level		1	25 min. 250/max, then 190	150 ... 210
Fish	One level		2	200	20 ... 30
When cooking with 2 trays at the same time, place the deeper tray on the upper rack and the other one on the lower rack. * It is suggested to perform preheating for all foods.					

(**) In a cooking that requires preheating, preheat at the beginning of cooking until the thermostat lamp turns off.

Tips for baking cake

- If the cake is too dry, increase the temperature by 10°C and decrease the cooking time.
- If the cake is wet, use less liquid or lower the temperature by 10°C.
- If the cake is too dark on top, place it on a lower rack, lower the temperature and increase the cooking time.
- If cooked well on the inside but sticky on the outside use less liquid, lower the temperature and increase the cooking time.

Tips for baking pastry

- If the pastry is too dry, increase the temperature by 10°C and decrease the cooking time. Dampen the layers of dough with a sauce composed of milk, oil, egg and yoghurt.
- If the pastry takes too long to bake, pay care that the thickness of the pastry you have prepared does not exceed the depth of the tray.
- If the upper side of the pastry gets browned, but the lower part is not cooked, make sure that the amount of sauce you have used for the pastry is not too much at the bottom of the pastry. Try to scatter the sauce equally between the dough layers and on the top of pastry for an even browning.



Cook the pastry in accordance with the mode and temperature given in the cooking table. If the bottom part is still not browned enough, place it on one lower rack next time.

Tips for cooking vegetables

- If the vegetable dish runs out of juice and gets too dry, cook it in a pan with a lid instead of a tray. Closed vessels will preserve the juice of the dish.
- If a vegetable dish does not get cooked, boil the vegetables beforehand or prepare them like canned food and put in the oven.

How to operate the top oven

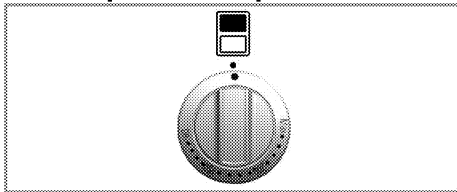

Grill oven can be used both as a grill and a baking oven. Switch on the top oven operates the oven when the oven door is closed, and the grill when the oven door is opened.

Turning on the oven

Oven is operated with Function knob. Oven is turned off when the Function knob is in Off (upper) position.

1. Close the oven door.
2. Set the oven temperature.
» Temperature light will turn of when the set temperature is attained.

Turning off the grill oven

1. Turn the Function knob to Off (top) position.

Cooking times table



The timings in this chart are meant as a guide. Timings may vary due to temperature of food, thickness, type and your own preference of cooking.



Maximum load capacity of oven tray: 4 kg (8.8 lb).



1st rack of the oven is the **bottom** rack.

- Do not place cookware with rough bases on the oven door.
- Ensure that there is at least 25mm space at top of oven when cooking larger foods or using taller cookware.

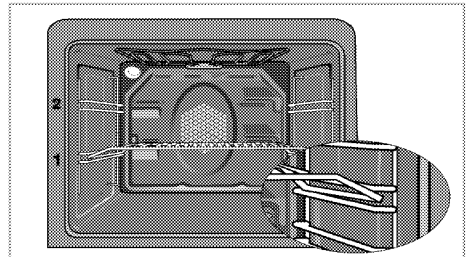

It is important to position the wire grill on the wire shelf correctly. The wire grill must be placed so that it will fit into the opening of the wire shelf as illustrated in the figure.

When removing tray from top oven, pull as shown in picture and hold with two hands from two sides.

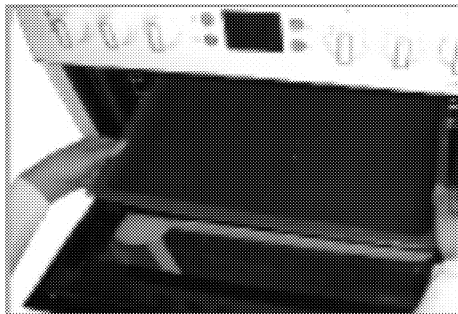
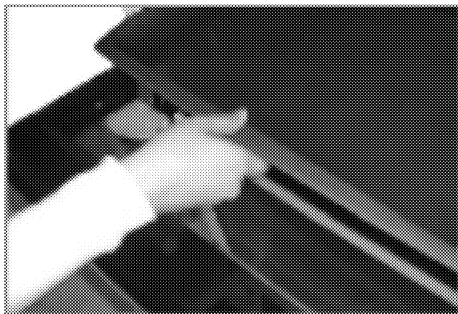

Baking and roasting



1st rack of the oven is the **bottom** rack.

Food	Cooking level number	Position	Rack position	Temperature (°C)	Cooking time (min.) (approx.)
Cake in tray	One level	<input type="checkbox"/>	1	175	25 ... 35
Cakes in paper	One level	<input type="checkbox"/>	1	175	25 ... 30
Sponge cake	One level	<input type="checkbox"/>	1	200	5 ... 10
Cookies	One level	<input type="checkbox"/>	1	175	25 ... 30
Dough pastry	One level	<input type="checkbox"/>	1	200	35 ... 40
Filled savory pastry	One level	<input type="checkbox"/>	1	180	25 ... 35
Beefsteak (whole)/ Roast	One level	<input type="checkbox"/>	1	25 min. 250 after 160 ... 190	100 ... 120
Roast chicken (Sliced)	One level	<input type="checkbox"/>	1	15 min. 250 after 190	55 ... 65
Fish	One level	<input type="checkbox"/>	1	200	20 ... 30

How to operate the top grill



WARNING

Hot surfaces may cause burns! Keep children away from the product.

Oven door remains slightly inclined when opened full and thus, possible splashes to not reach you.

There is a switch on the door. As a safety precaution, this switch prevents operation of the grill when the door is **CLOSED**.

Grill oven can be used both as a grill and a baking oven. Switch on the top oven operates the oven when the oven door is closed, and the grill when the oven door is opened.

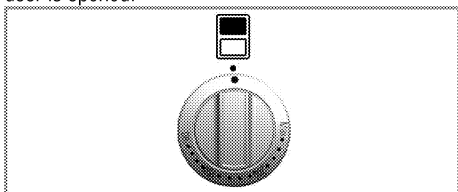

Switching on the grill

Grill is operated with Function knob. Grill is turned off when the Function knob is in Off (upper) position.

1. Open the oven / grill door.
2. Set the grill temperature to 150 °C and if required, perform a preheating for about 5 minutes.
3. Then, select the desired grilling temperature.
» Thermostat (temperature) light turns on.

Turning off the grill oven

1. Turn the Function knob to Off (top) position.
 - Put big or medium-sized portions in correct rack position under the grill heater for grilling.
 - For food only whose top is required to be roasted, grill the food either by placing onto the wire grill in the tray or by placing the tray onto the floor of grilling compartment.
 - Food and plates placed onto the floor of grill compartment will get heated when the main oven is in use. Do not switch on the grill food compartment when using it for storing food.

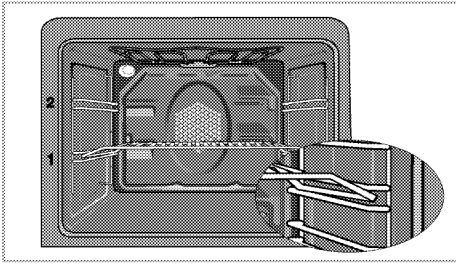

Foods that are not suitable for grilling carry the risk of fire. Only grill food which is suitable for intensive grilling heat.

Do not place the food too far in the back of the grill. This is the hottest area and fatty food may catch fire.

Top oven cooking times table for grilling

Grilling with electric grill



1st rack of the oven is the **bottom** rack.

Food	Insertion level	Grilling time (approx.)
Fish	1..2	20..25 min. [#]
Sliced chicken	1..2	25..35 min.
Lamb chops	1..2	20..25 min.
Roast beef	1..2	25..30 min. [#]
Veal chops	1..2	25..30 min. [#]
Toast bread	1..2	1..2 min.
[#] depending on thickness		

7 Maintenance and care

General information

Service life of the product will extend and the possibility of problems will decrease if the product is cleaned at regular intervals.

 **DANGER:**
Disconnect the product from mains supply before starting maintenance and cleaning works.
There is the risk of electric shock!

 **DANGER:**
Allow the product to cool down before you clean it.
Hot surfaces may cause burns!

- Clean the product thoroughly after each use. In this way it will be possible to remove cooking residues more easily, thus avoiding these from burning the next time the appliance is used.
- No special cleaning agents are required for cleaning the product. Use warm water with washing liquid, a soft cloth or sponge to clean the product and wipe it with a dry cloth.
- Always ensure any excess liquid is thoroughly wiped off after cleaning and any spillage is immediately wiped dry.
- Do not use cleaning agents that contain acid or chloride to clean the stainless or inox surfaces and the handle. Use a soft cloth with a liquid detergent (not abrasive) to wipe those parts clean, paying attention to sweep in one direction.

 The surface might get damaged by some detergents or cleaning materials.
Do not use aggressive detergents, cleaning powders/creams or any sharp objects during cleaning.
Do not use harsh abrasive cleaners or sharp metal scrapers to clean the oven door glass since they can scratch the surface, which may result in shattering of the glass.

 Do not use steam cleaners to clean the appliance as this may cause an electric shock.

Cleaning the hob

Glass ceramic surfaces

Wipe the glass ceramic surface using a piece of cloth dampened with cold water in a manner as not to leave any cleaning agent on it. Dry with a soft and dry cloth. Residues may cause damage on the glass ceramic surface when using the hob for the next time.

Dried residues on the glass ceramic surface should under no circumstances be scraped with hook blades, steel wool or similar tools.

Remove calcium stains (yellow stains) by a small amount of lime remover such as vinegar or lemon juice. You can also use suitable commercially available products.

If the surface is heavily soiled, apply the cleaning agent on a sponge and wait until it is absorbed well. Then, clean the surface of the hob with a damp cloth.

 Sugar-based foods such as thick cream and syrup must be cleaned promptly without waiting the surface to cool down. Otherwise, glass ceramic surface may be damaged permanently.

Slight color fading may occur on coatings or other surfaces in time. This will not affect operation of the product.

Color fading and stains on the glass ceramic surface is a normal condition, and not a defect.

Cleaning the control panel

Clean the control panel and knobs with a damp cloth and wipe them dry.

 Do not remove the control buttons/knobs to clean the control panel.
Control panel may get damaged!

Cleaning the oven

To clean the side wall

1. Remove the front section of the side rack by pulling it in the opposite direction of the side wall.
2. Remove the side rack completely by pulling it towards you.

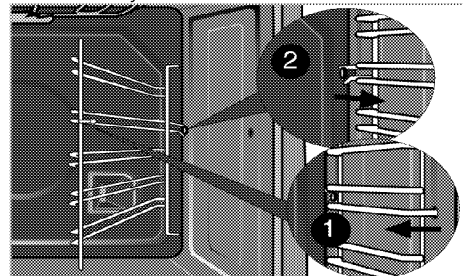

Catalytic walls

Side walls or just back wall of oven interior may be covered with catalytic enamel.

The catalytic walls of the oven must not be cleaned. The porous surface of the walls is self-cleaning by absorbing and converting spitting fat (steam and carbon dioxide).

Clean oven door

To clean the oven door, use warm water with washing liquid, a soft cloth or sponge to clean the product and wipe it with a dry cloth.

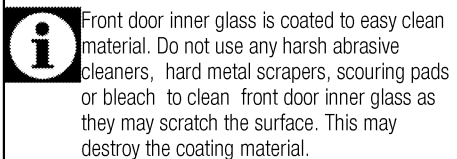
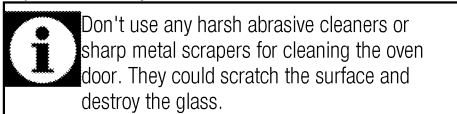

Removing the upper oven door

1. Open the front door (1).
2. Open the clips at the hinge housing (2) on the right and left hand sides of the front door by pressing them down as illustrated in the figure.

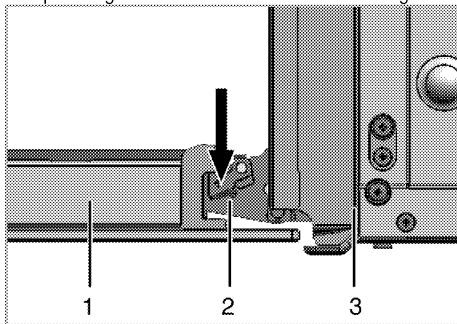

- 1 Front door
- 2 Hinge
- 3 Oven

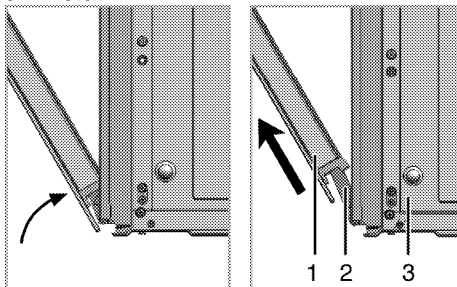

3. Move the front door to half-way.
4. Remove the front door by pulling it upwards to release it from the right and left hinges.

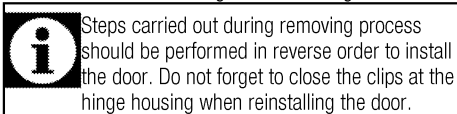

Removing the door inner glass

1. Open the oven door.
2. Remove the metal part (1) by removing the screws that secure it.
3. To remove the plastic holders (2), use a flat metal or plastic, e.g., a knife, slotted screwdriver, to free the fixing foot (5).
4. Push the fixing foot through the window (6) in arrow direction.

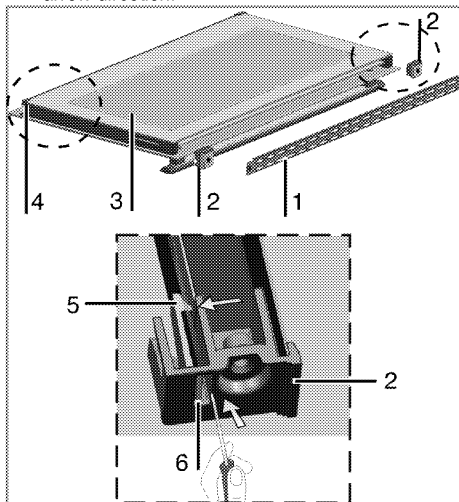

- 1 Metal part
- 2 Plastic carrier
- 3 Inner glass panel
- 4 Lower plastic slot
- 5 Fixing foot
- 6 Window

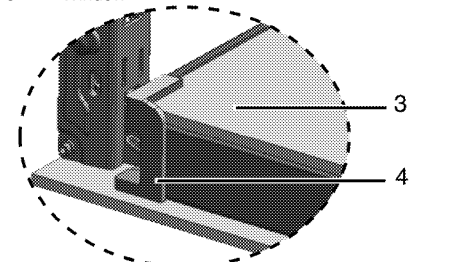

5. Pull the inner glass panel (3) towards yourself until it detaches from its plastic slots (4).
6. Pull innermost glass panel towards yourself until it detaches from its plastic slots (4) like inner glass panel.
7. When reinstalling the glass panel, make sure that it is seated into the plastic slots.

Replacing the oven lamp



DANGER:

Before replacing the oven lamp, make sure that the product is disconnected from mains and cooled down in order to avoid the risk of an electrical shock.
Hot surfaces may cause burns!



The oven lamp is a special electric light bulb that can resist up to 300 °C. See *Technical specifications, page 10* for details. Oven lamps can be obtained from Authorised Service Agents or technician with licence.



Position of lamp might vary from the figure.

If your oven is equipped with a round lamp:

1. Disconnect the product from mains.
2. Turn the glass cover counter clockwise to remove it.

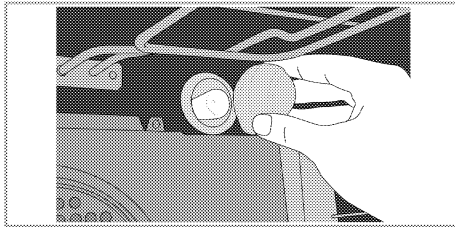

3. Remove the oven lamp by turning it counter clockwise and replace it with the new one.
4. Install the glass cover.

8 Troubleshooting

Oven emits steam when it is in use.

- It is normal that steam escapes during operation. >>> *This is not a fault.*

Product emits metal noises while heating and cooling.

- When the metal parts are heated, they may expand and cause noise. >>> *This is not a fault.*

Product does not operate.

- The mains fuse is defective or has tripped. >>> *Check fuses in the fuse box. If necessary, replace or reset them.*
- Product is not plugged into the (grounded) socket. >>> *Check the plug connection.*

Oven light does not work.

- Oven lamp is defective. >>> *Replace oven lamp.*
- Power is cut. >>> *Check if there is power. Check the fuses in the fuse box. If necessary, replace or reset the fuses.*

Oven does not heat.

- Function and/or Temperature are not set. >>> *Set the function and the temperature with the Function and/or Temperature knob/key.*
- In models equipped with a timer, the timer is not adjusted. >>> *Adjust the time.*
(In products with microwave oven, timer controls only microwave oven.)
- Power is cut. >>> *Check if there is power. Check the fuses in the fuse box. If necessary, replace or reset the fuses.*

(In models with timer) Clock display is blinking or clock symbol is on.

- A previous power outage has occurred. >>> *Adjust the time / Switch of the product and switch it on again.*



Consult the Authorised Service Agent or technician with licence or the dealer where you have purchased the product if you can not remedy the trouble although you have implemented the instructions in this section. Never attempt to repair a defective product yourself.

9 Guarantee and Service

Your Beko product is guaranteed against the cost of breakdown repairs : Freestanding appliances : 1 year
Built-in appliances : 2 year
from the date of the original purchase.

What is covered?

- All repairs necessary as a result of faulty materials, defective components or manufacturing defect.
- The cost of all functional replacement parts.
- The labour costs of a Beko approved repairer to carry out the repair.

What is not covered?

- Transit or delivery damage
- Accidental damage
- Misuse, or abuse.
- Cabinet or appearance parts, including knobs and flaps
- Accessory items, including ice trays, scrapers, cutlery baskets,
- Repairs required as a result of unauthorised repairs or inexpert installation that fails to meet the requirements contained in the user instruction book.

Repairs to products used on commercial or non-residential household premises.

Important notes.

- The product is guaranteed for domestic household use only.
- The guarantee will be void if the product is installed or used in commercial or non-residential household premises.
- The product must be correctly installed, located and operated in accordance with the instructions contained in the User Instructions Booklet provided.
- Professional Installation by a qualified plumber/electrical appliance installer is recommended for all Washing & Dishwashing Machines and Electric Cookers
- Gas Cookers must only be installed by a Gas Safe (or BORD GAIS) registered Gas Installer.
- The guarantee is given only within the boundaries of the United Kingdom.
- The guarantee is not transferable if the product is resold.
- Beko plc disclaims any liability for incidental or consequential damages.
- The guarantee does not in anyway diminish your statutory or legal rights.

HOW TO OBTAIN SERVICE UNDER THE MANUFACTURERS GUARANTEE

Please keep your purchase receipt or other proof of purchase in a safe place; you will need to have it should the product require attention in the guarantee period

You should also complete the details below; it will help us assist you quicker when requesting service. (The model number is printed on the Instruction Booklet)

Model Number: _____ Purchased From: _____ Date of purchase: _____

For service under guarantee simply telephone the appropriate number below

LOCATION

TELEPHONE

UK Mainland & Northern Ireland

Fridges & Freezers	0845 600 4903/0345 600 4903
Electric Cookers	0845 600 4902/0345 600 4902
Gas & Dual Fuel Cookers	0845 600 4905/0345 600 4905
Washing Machines & Dishwashers	0845 600 4906//0345 600 4906

Republic of Ireland

All Refrigeration, Cooking, Washing & Dishwashing Machines 01 862 3411

Before requesting service please check the troubleshooting guide in the Operating Instructions as a charge may be levied where no fault is found even though your product may still be under guarantee.

Service once the manufacturers guarantee has expired.

If you have purchased an extended guarantee please refer to the instructions contained within the extended guarantee agreement document. Otherwise please call the above numbers where service can be obtained at a charge.

Should you experience any difficulty in obtaining service please call the

Beko Customer Help-Line on 0845 600 4911/0345 600 4911

Beko Plc, Beko House, 1 Greenhill Crescent, Watford Herts, WD18 8QU, Tel: 0845 600 4911

Beko plc
Beko House
1 Greenhill Crescent
Watford
Herts WD18 8QU
Tel: 0845 600 4911/0345 600 4911

Printed in
Part no : 285.3031.88
Rev: AA/ 08.05.2015